

REVISIONS			
REV.	DESCRIPTION	DATE	ECN
A	INITIAL RELEASE	4/22/09	1167

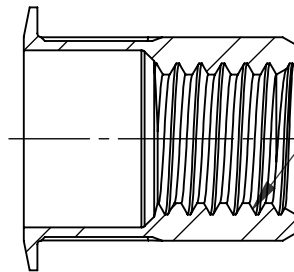

SECTION A-A

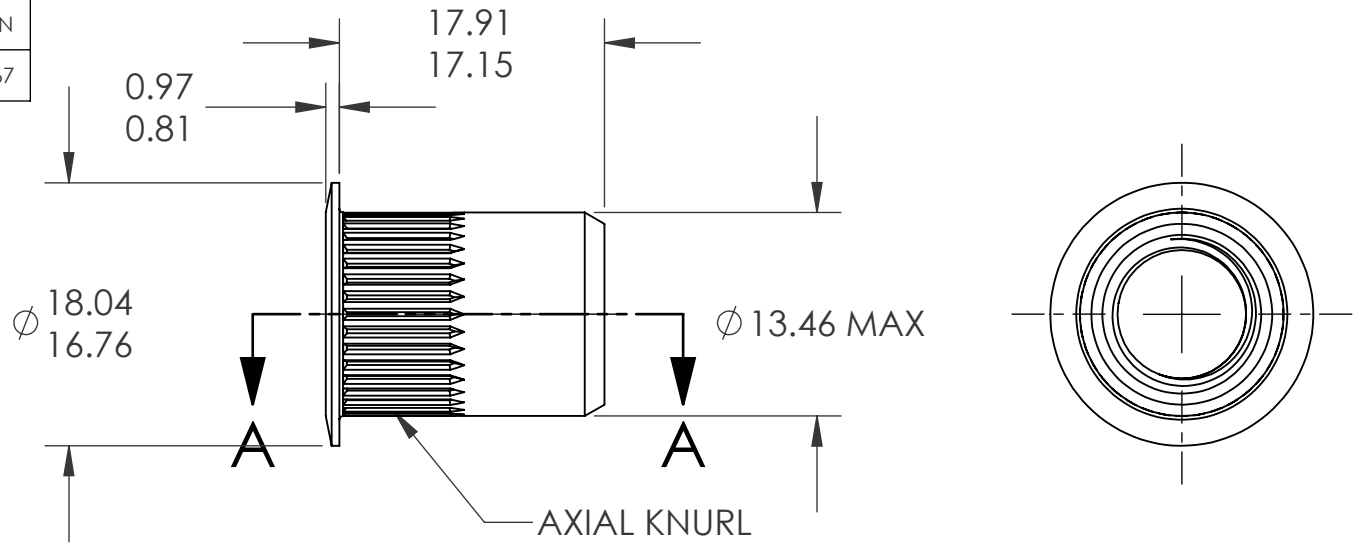
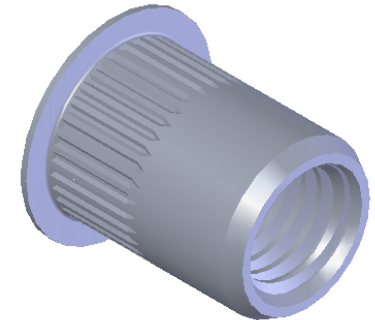

NOTE:

- GRIP RANGE: 0.70 - 3.80
- HOLE SIZE: 13.50 +0.15/-0.0 AFTER ALL APPLIED FINISHES.
- INSTALLED LENGTH: 11.94 MAX.
- LUBRICATION: NONE
- INSTALLATION TOOL: MS 100 SPIN PULL

**PROPRIETARY AND CONFIDENTIAL**

THIS DRAWING, AND THE INFORMATION CONTAINED HEREIN, ARE THE PROPERTY OF SHEREX AND ARE NOT TO BE USED IN ANY MANNER DETRIMENTAL TO THE INTEREST OF THE COMPANY.  
SHEREX SOLUTIONS RESERVES THE RIGHT TO REVISE PART/DRAWING WITHOUT NOTICE.

		UNLESS OTHERWISE SPECIFIED:		NAME	DATE
		DIMENSIONS ARE IN MILLIMETERS TOLERANCES: ANGULAR: MACH ± 1 BEND ± 1 ONE PLACE DECIMAL ± 0.10 TWO PLACE DECIMAL ± 0.05	DRAWN	TWR	4/22/09
		INTERPRET GEOMETRIC TOLERANCING PER: ASME Y14.5M-1994	CHECKED		
		MATERIAL	ENG APPR.	JVK	4/22/09
		302/303 STAINLESS	MFG APPR.		
		FINISH	Q.A.	JVK	4/22/09
		PASSIVATE	COMMENTS:		
NEXT ASSY	USED ON		E-mail: info@sherex.com www.sherex.com Phone: 866-474-3739 Fax: 716-875-0358		
APPLICATION		DO NOT SCALE DRAWING			

		
TITLE:		
LARGE FLANGE OPEN END		
SIZE	DWG. NO.	REV
<b>A</b>	CAL1-1015-3.8	A
SCALE: 2:1	WEIGHT: kg	SHEET 1 OF 1